

MODEL 6600 Downflow - V2.0

Option Setting Level #1

Programming Chart

Level #1

NOTE:

1. Push Program Button once per display.
2. Option setting may be changed by pushing either the Up or Down Arrow Button.
3. Depending on current valve programming certain displays will not be able to be viewed or set.

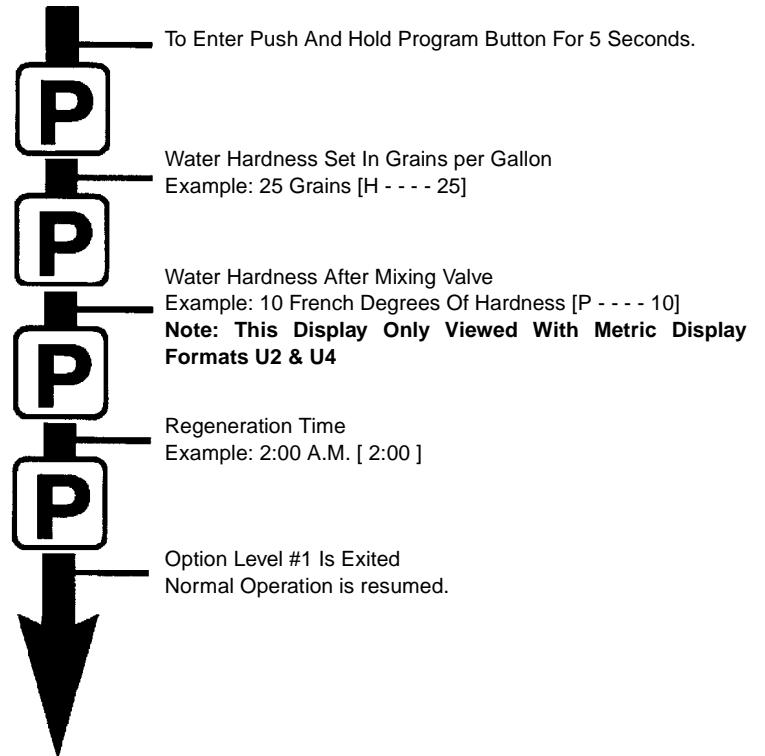

MODEL 6600 Downflow - V2.0

Option Setting Level #1

Installer Programming

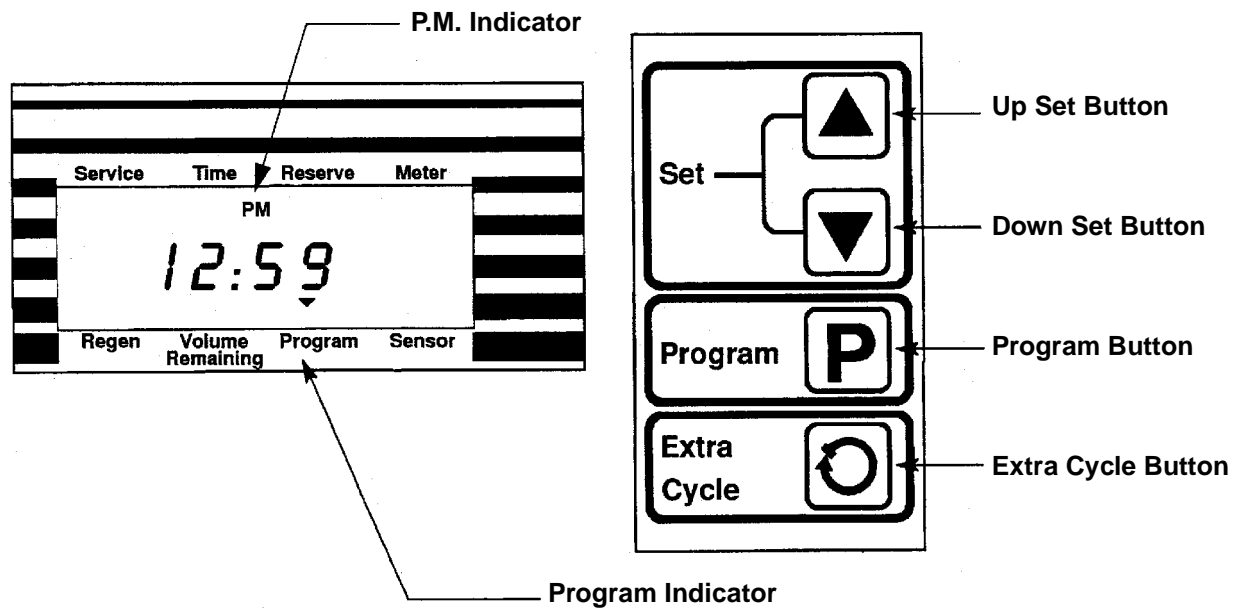

Setting up the valve during installation requires access to the first level of option programming.

Entering Option Level #1

Depress for 5 seconds the Program Button. The Program Arrow will turn on and the first display viewed is used to set the Inlet Water Hardness. Depending on current programming, certain displays or option settings will not be viewed.

1. Water Hardness (H)

The unit of measure used for this setting is grains/French degrees/P.P.M./German degrees. This option setting is identified by the letter H in the first digit.

Example: 25 grains [H - - - - 25]

The **UP** and **DOWN Set Buttons** will adjust this value.

2. Water Hardness After Mixing Valve (P)

Depress the Program Button. The next display viewed is the option setting for water hardness after the mixing valve. The unit of measure used for this setting is French degrees or P.P.M. This display will only be able to be viewed with US/metric Display Format set to U-2 or U-4 (metric formats). This option setting is identified by the letter P in the first digit.

Example: 10 French degrees of Hardness [P - - - - 10]

The **UP** and **DOWN SET Buttons** will adjust this value.

3. Regeneration Time

Depress the Program Button. The next display viewed is the option setting for Regeneration Time. It is identified by a non-flashing colon between two sets of numbers.

Example: 2 o'clock A.M. regeneration time [2:00] (P.M. Indicator Off)

The **UP** and **DOWN Set Buttons** will adjust this value. Exiting This Option Setting Level

Exiting This Option Setting Level

Push the Program Button once per display until all have been viewed.

MODEL 6600 Downflow - V2.0

Option Setting Level #1

Installer Programming (Cont'd.)

Installer Notes

1. Control Calculations - With Delayed Regeneration Valves, the control is designed to automatically calculate its reserve capacity based on daily water usage. There is no need to program in a reserve capacity. The System Capacity Option Setting should be set to the resin bed manufacturer's capacity recommendations for a given amount of salt to be used during regeneration.
2. With Immediate Regeneration Valves, the System Capacity Option Setting should also be set to the resin bed manufacturer's capacity recommendations for a given amount of salt to be used during regeneration.
3. System Capacity and Water Hardness displays will not be able to be viewed or set with non-metered systems.
4. Regeneration Time will not be able to be viewed or set with Immediate Regeneration Valves.
5. Acceptable voltage range for reliable control operation:
24 Vac Valves + or - 10% 50/60 Hz

MODEL 6600 Downflow - V2.0

Option Setting Level #2

Programming Chart

NOTE:

1. Push Program Button once per display.
2. Option settings may be changed by pushing either the Up or Down Arrow Button.
3. Depending on current valve programming certain displays will not be able to be viewed or set.

Level #2

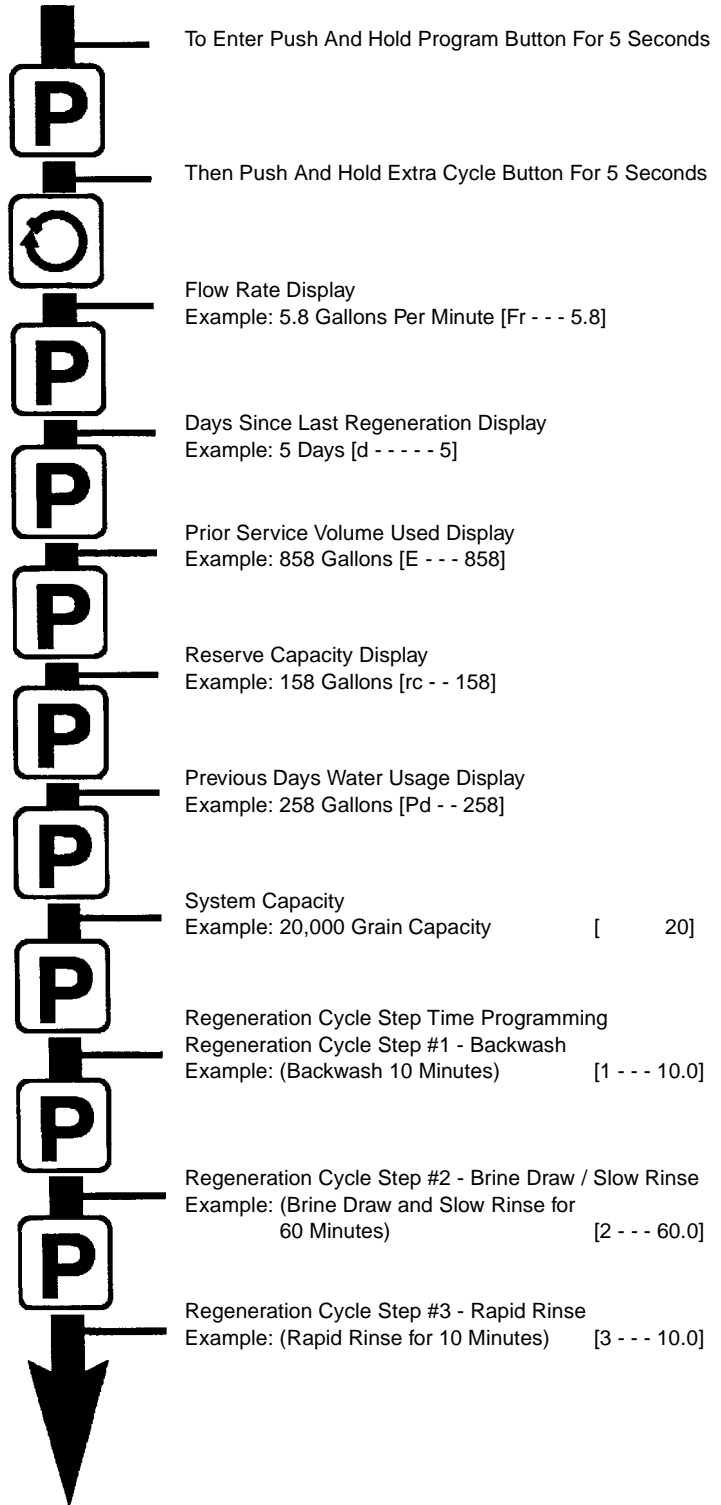

Continued On Next Page

MODEL 6600 Downflow - V2.0

Option Setting Level #2

Programming Chart (Cont'd.)

Level #2 Continued

NOTE:

1. Push Program Button once per display.
2. Option settings may be changed by pushing either the Up or Down Arrow Button.
3. Depending on current valve programming certain displays will not be able to be viewed or set.

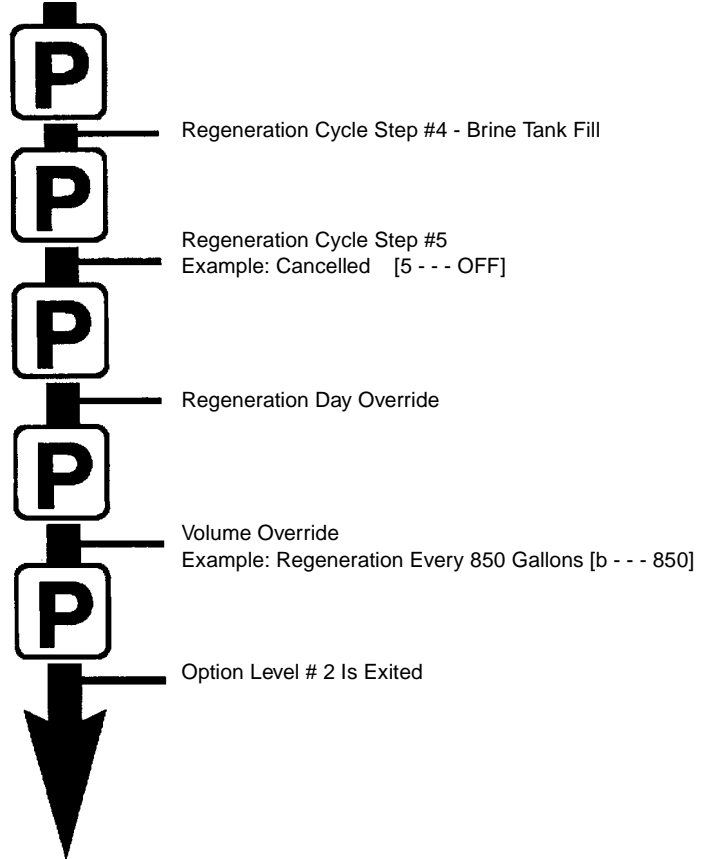

MODEL 6600 Downflow - V2.0

Option Setting Level #2

Softener Manufacturer Programming

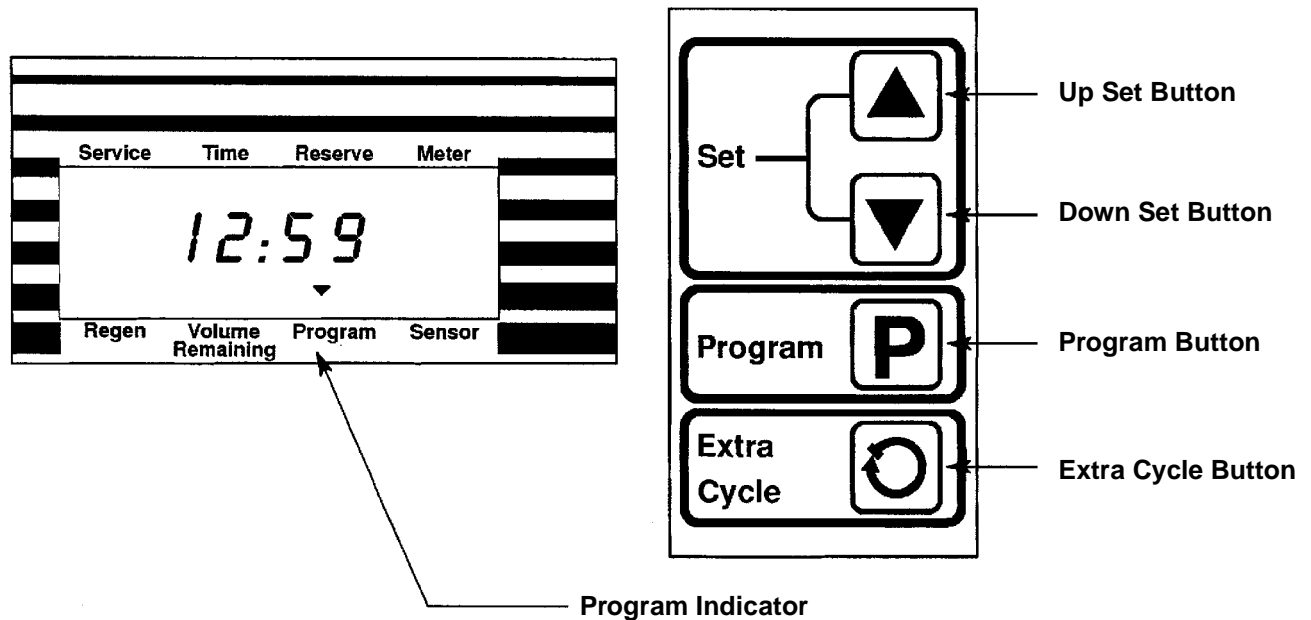

Setting up the valve during manufacturing of the softener requires access to the second level of option programming. This level includes the functioning parameters of the softener, related to actual system configuration.

Entering Option Level #2

Depress for 5 seconds the Program Button. The Program Arrow will turn on and the first display viewed is used to set the Inlet Water Hardness. Next, depress the Extra Cycle Button for 5 seconds. Depending on current programming, certain displays or option settings will not be viewed.

1. Flow Rate Display (Fr)

The first display viewed is the current flow rate of treated water through the softener. The unit of measurement used is gallons/liters per minute. This display is identified by the letters Fr in the first two digits.

Example: 8.5 Gallons Per Minute [Fr - - - 8.5]

2. Days Since Last Regeneration Display (d)

Depress the Program Button. The next display viewed is not an option setting. This display is used as an aid to the service person in diagnosing a valve malfunction. The number of days since the last regeneration is recorded in this display by the control. This display is identified by the letter d in the first digit.

Example: 4 days [d - - - - 4]

3. Prior Service Volume Used Display (E)

Depress the Program Button. The next display viewed is not an option setting. This display is used as an aid to the service person in diagnosing a valve malfunction. The amount of water used the last time the softener was in service is recorded in this display by the control. The unit of measurement used is gallons/liters/cubic meters. This display is identified by the letter E in the first digit.

Example: 850 Gallons [E - - - 850]

MODEL 6600 Downflow - V2.0

Option Setting Level #2

Softener Manufacturer Programming (Cont'd.)

4. Reserve Capacity Display (rc)

Depress the Program Button. The next display viewed is not an option setting. This display is used as an aid to the service person in diagnosing a valve malfunction. The calculated reserve capacity (in gallons/liters/cubic meters) for the present day is recorded in this display by the control. This display is identified by the letters rc in the first two digits.

Example: 277 gallons [rc - - 277]

5. Previous Days Water Usage Display (Pd)

Depress the Program Button. The next display viewed is not an option setting. This display is used as an aid to the service person in diagnosing a valve malfunction. The previous days water usage (in gallons/liters/cubic meters) is recorded in this display by the control. This display is identified by the letters Pd in the first two digits.

Example: 200 Gallons [Pd - - 200]

6. System Capacity (C)

Depress the Program Button. The next display viewed is the option setting for Capacity. The unit of measurement used for this setting is kilograins/French degree x m³/grams/German degree x m³. The total capacity of the softener is set with this display. The control will calculate a reserve, if required. This option setting is identified by the letter C in the first digit.

Example: 20,000 grain capacity [C - - - - 20]

The **UP** and **DOWN Set Buttons** adjust these settings.

7. Regeneration Cycle Step Programming (1) (2) (3) (4) (5) (6)

Depress the Program Button. The next 4-6 displays viewed are part of a series of option settings used to program the Regeneration Cycle. Up to 6 steps can be programmed. Each display is used to set the duration time in minutes of that specific step in a regeneration cycle. A step # will turn on for the regeneration cycle step being programmed. The first display in the series is Regeneration Cycle Step #1 (Backwash). Steps are skipped by setting the display to 0 and regeneration ended by setting the step # after the last active step to OFF, as shown below:

Examples: Regeneration Cycle Step #1 - (Backwash) 8 minutes [1 - - - - 8.0]
 Regeneration Cycle Step #4 - (Brine Tank Refill) 8-1/2 minutes [4 - - - - 8.5]

Depress the Program Button once per display to advance through Regeneration Cycle Step Programming.

The 6600 control has a separate brine tank fill cycle. Your desired salt setting must be calculated, using the blue (.25 gpm) or black (.5 gpm) rate of refill (in gpm) times your timer setting. Then using one gallon of fresh water dissolving approximately 3 lbs. of salt, calculate your refill time.

Example: lbs. salt ÷ 3 ÷ B.L.F.C. Size = refill time in minutes, 10 lbs. salt ÷ 3 ÷ .25 = 13.3 minute refill.

Steps #5 and #6 are not presently used with the 6600 valve and must be cancelled.

Examples: Regeneration Cycle Step #5 - (5.0 Minutes) [5 - - - OFF]
 Regeneration Cycle Step #6 - (Not Viewed)

The **UP** and **DOWN Set Buttons** adjust these settings.

MODEL 6600 Downflow - V2.0

Option Setting Level #2

Softener Manufacturer Programming (Cont'd.)

8. Cycle Step Location For Chlorination Indicator (J)

Depress the Program Button. The next display viewed is an option setting. This display is used to set the desired regeneration cycle step number where the chlorinator indicator (C) will turn on in the regeneration display. Actual control of power to a chlorinator is handled independently of this setting using a microswitch or Timed Aux. Output. This option setting is identified by the letter J in the first digit.

Examples: No Chlorinator Installed - [J - - - OFF]
Chlorinator To Turn On During Step #2 - [J - - - - 2]
Regeneration Display With Chlorinator Indicator ON - [2C - - 38.2]

The **UP** and **DOWN Set Buttons** adjust this value.

9. Regeneration Day Override (A)

Depress the Program Button. The next display viewed is a option setting. This display is used to set a regeneration day override. The Regeneration Day Override Option Setting sets the maximum amount of time (in days) the softener can be in service without a regeneration, regardless of the volume of water used or the lack of a sensor signal. Regeneration begins at the set regeneration time. An OFF setting will cancel this option with all regeneration types except Timeclock Regeneration. This option setting is identified by the letter A in the first digit.

Examples: Override every 7 days - [A - - - - 7]
Cancel setting - [A - - - OFF]

The **UP** and **DOWN Set Buttons** adjust this value.

10. Volume Override (b)

Depress the Program Button. The next display viewed is a option setting. This display is used to set a volume override. The Volume Override Option Setting is used to set the maximum amount of water that can be used before a regeneration cycle is called for. When this feature is used with delayed regeneration systems, it will be up to the programmer to determine a reserve capacity. The control will no longer keep track of the reserve capacity. This option is typically used to bypass standard reserve or capacity calculations made by the control. This option setting is identified by the letter b in the first digit.

Examples: Override every 700 gallons - [b - - - 700]
Override cancelled - [b - - - OFF]

The **UP** and **DOWN Set Buttons** adjust this value.

Exiting This Option Setting Level

Push the Program Button once per display until all have been viewed.

MODEL 6600 Downflow - V2.0

Option Setting Level #3

Programming Chart

Level #3

NOTE:

1. Push Program Button once per display.
2. Option setting may be changed by pushing either the Up or Down Arrow Button.
3. Depending on current valve programming certain displays will not be able to be viewed or set.

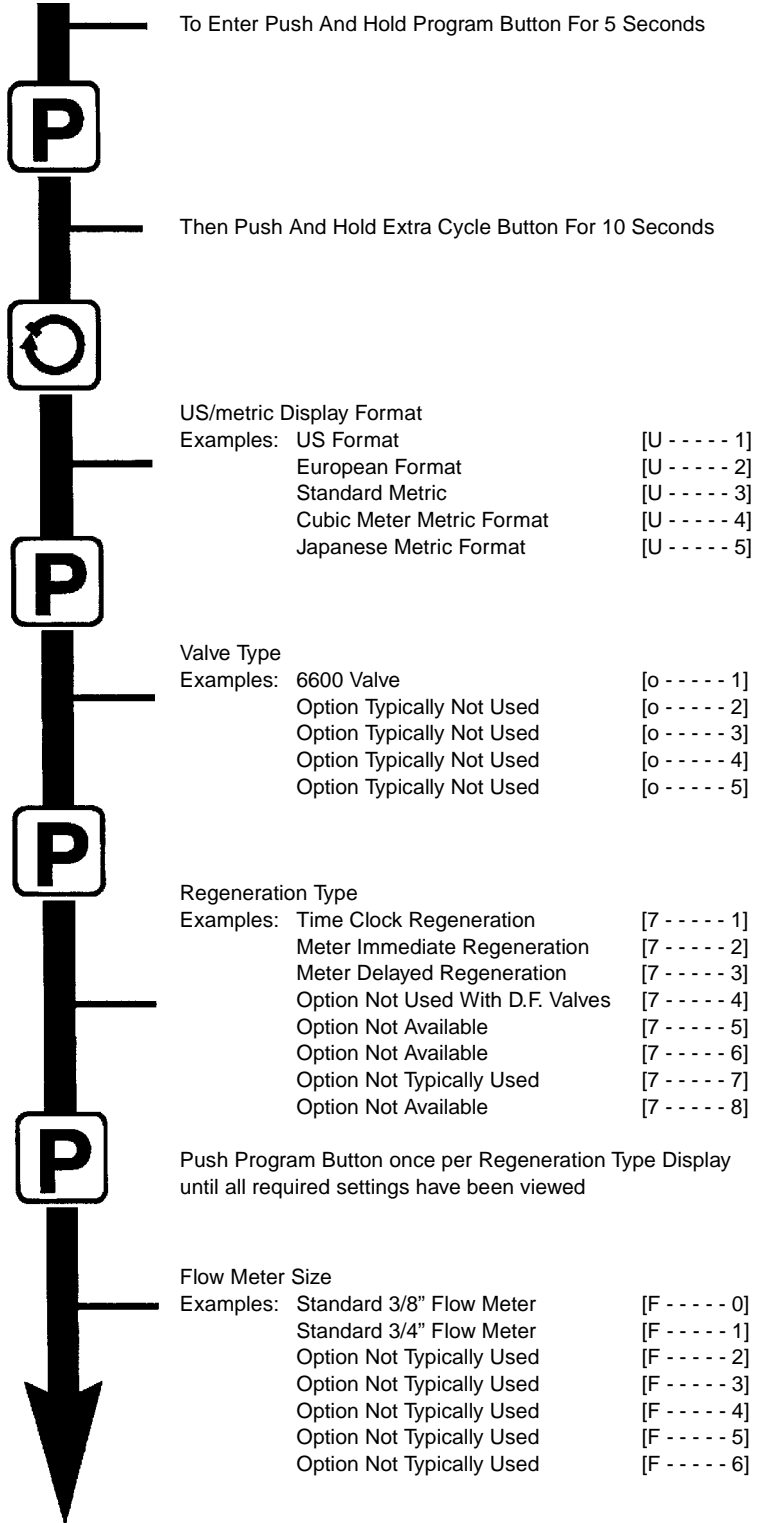

Continued On Next Page

MODEL 6600 Downflow - V2.0

Option Setting Level #3

Programming Chart (Cont'd.)

Level #3 Continued

NOTE:

1. Push Program Button once per display.
2. Option settings may be changed by pushing either the Up or Down Arrow Button.
3. Depending on current valve programming certain displays will not be able to be viewed or set.



Mixing Valve Location

Examples: No Mixing Valve [8 - - - - 1]
Mixing Valve Before Flow Meter [8 - - - - 2]
Mixing Valve After Flow Meter [8 - - - - 3]

Note: This Display Only Viewed With Metric Formats U2 & U4

System Type

Examples: Single Valve System #4 Operation [9 - - - - 4]
Option Not Currently Offered [9 - - - - 5]
Option Not Currently Offered [9 - - - - 6]
Option Not Currently Offered [9 - - - - 7]

Program Lock

Example: Lock Cancelled [PL - - - OFF]
Lock Active [PL - - - On]

Option Level #3 Is Exited
Normal Operation is resumed

MODEL 6600 Downflow - V2.0

Option Setting Level #3

Valve Manufacturer Programming

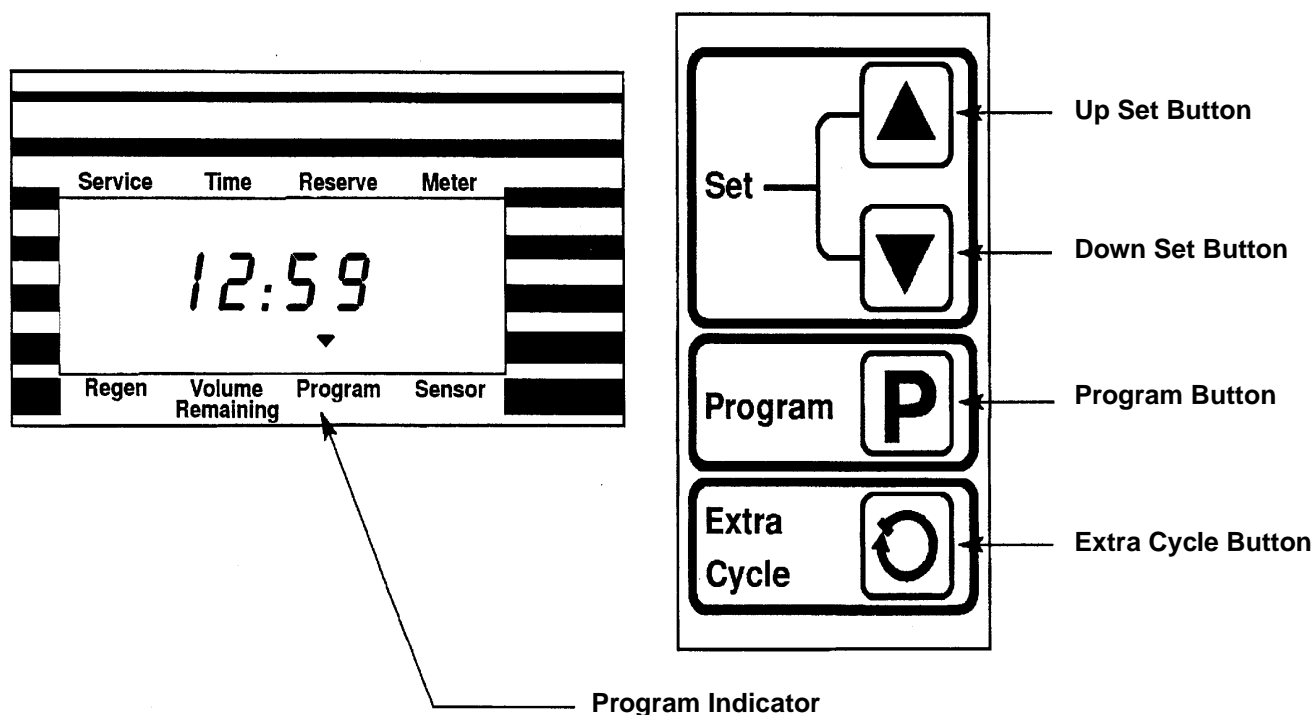

Setting up the valve during manufacturing of the softener valve requires access to the third level of option programming. This level includes the basic functioning parameters related to the proper operation of the valve.

Entering Option Level #3

Depress for 5 seconds the Program Button. The Program Arrow will turn on and the first display viewed is used to set the Inlet Water Hardness. Next, depress the Extra Cycle Button for 10 seconds. Depending on current programming, certain displays or option settings will not be viewed.

1. US/Metric Display Format (U)

Depress the Program Button. The next display viewed is an option setting. This display is used to set the desired display format. This option setting is identified by the letter U in the first digit. There are five possible settings:

The US Format uses gallons for volume and gallons per minute for flow rate related data / displays with a 12 hour timekeeping format. Water Hardness units will be grains per gallon and Capacity in kilograins. Mixing valve related option settings P and 8 as well as Regeneration Types #7 and #8 will not be displayed.

Example: [U - - - - 1]

The European Metric Format uses liters for volume and liters per minute for flow rate related data / displays with a 24 hour timekeeping format. Water Hardness units will be French Degrees and Capacity in French Degree x m³.

Example: [U - - - - 2]

MODEL 6600 Downflow - V2.0

Option Setting Level #3

Valve Manufacturer Programming (Cont'd.)

The Standard Metric Format uses liters for volume and liters per minute for flow rate related data / displays with a 24 hour timekeeping format. Water Hardness units will be French Degrees and Capacity in French Degree x m³. Mixing valve related option settings P and 8 as well as Regeneration Types #7 and #8 will not be displayed.

Example: [U - - - - - 3]

The Cubic Meter Metric Format uses m³ for volume and liters per minute for flow rate related data / displays with a 24 hour timekeeping format. Water Hardness units will be P.P.M. (mg/liter or g/m³) and Capacity in grams. Regeneration Types #7 and #8 will not be displayed.

Example: [U - - - - - 4]

The Japanese Metric Format uses liters for volume and liters per minute for flow rate related data / displays with a 24 hour timekeeping format. Water Hardness units will be German Degrees and Capacity in German Degree x m³. Mixing valve related option settings P and 8 as well as Regeneration Types #7 and #8 will not be displayed.

Example: [U - - - - - 5]

The **UP** and **DOWN Set Buttons** adjust this value.

2. Valve Type (o)

Depress the Program Button. The next display viewed is not an option setting. This display is used to set the type of valve used with the control. This option setting is identified by the letter o in the first digit. There are five possible selections with #1 being the required setting:

Examples: [o - - - - - 1] 6600 Valve Operation.
 [o - - - - - 2] Option Typically Not Used
 [o - - - - - 3] Option Typically Not Used
 [o - - - - - 4] Option Typically Not Used
 [o - - - - - 5] Option Typically Not Used

The **UP** and **DOWN Set Buttons** adjust this value.

3. Regeneration Type (7)

Depress the Program Button. The next display viewed is an option setting. This display is used to set the Regeneration Type. This option setting is identified by the number 7 in the first digit. There are 8 possible settings:

Time Clock Delayed. The control will determine that regeneration is required when the set Regeneration Time has been reached. The Regeneration Day Override setting will determine on which days a regeneration cycle will be initiated.

Example: [7 - - - - - 1]

Meter Immediate. The control will determine that regeneration is required when the available volume softened water drops to or below zero. Regeneration to begin immediately.

Example: [7 - - - - - 2]

MODEL 6600 Downflow - V2.0

Option Setting Level #3

Valve Manufacturer Programming (Cont'd.)

Meter Delayed. The control will determine that a regeneration is required when the available volume of softened water drops to or below the reserve capacity. Regeneration is to begin immediately at the set Regeneration Time up to an additional 20 minutes, with service flow. Regeneration then to begin immediately. There will not be a delay if the Volume Remaining is zero.

Examples: [7 - - - - 3]
[7 - - - - 4] Option Typically Not Used With Downflow Valves
[7 - - - - 5] Option Typically Not Used
[7 - - - - 6] Option Typically Not Used
[7 - - - - 7] Option Typically Not Used
[7 - - - - 8] Option Not Available

4. Flow Meter Size (F)

Depress the Program Button. The next display viewed is an option setting and is used to set the flow meter size. This setting will not be viewed on non-metered valves. This option setting is identified by the letter F in the first digit. There are six possible selections with #0 or #1 the desired setting:

Examples: [F - - - - 0] Standard 3/8" Flow Meter
[F - - - - 1] Standard 3/4" Flow Meter
[F - - - - 2] Option Not Typically Used
[F - - - - 3] Option Not Typically Used
[F - - - - 4] Option Not Typically Used
[F - - - - 5] Option Not Typically Used
[F - - - - 6] Option Not Typically Used

The **UP** and **DOWN Set Buttons** adjust this value.

5. Mixing Valve Location (8)

Depress the Program Button. The next display viewed is an option setting and is used to set where the mixing valve is located. Viewed only with the US/metric Display Format set to U-2 or U-4. This option setting is identified by the number 8 in the first digit. There are three possible settings:

Examples: [8 - - - - 1] No Mixing Valve
[8 - - - - 2] Mixing Valve Before Flow Meter
[8 - - - - 3] Mixing Valve After Flow Meter

The **UP** and **DOWN Set Buttons** adjust this value.

MODEL 6600 Downflow - V2.0

Option Setting Level #3

Valve Manufacturer Programming (Cont'd.)

6. System Type (9)

Depress the Program Button. The next display viewed is an option setting. This display is used to set the type of system the valve is operating in. This option setting is identified by the number 9 in the first digit. There are four possible selections with #4 the desired setting:

Single Valve Meter or Sensor Regeneration - When this option is selected, the control will operate as a stand alone unit. The control can initiate a regeneration whenever needed. When a Lockout Signal is received, the control will delay the start of regeneration until that signal is removed.

Examples: [9 - - - - 4] Single Valve System #4 Operation
 [9 - - - - 5] Option Not Available
 [9 - - - - 6] Option Not Available
 [9 - - - - 7] Option Not Available

The **UP** and **DOWN Set Buttons** adjust this value.

7. Program Lock (PL)

Depress the Program Button. This display is used to prevent certain displays from being viewed or set. There are two possible settings:

Examples: [PL - - - OFF] Lock Cancelled
 [PL - - - ON] Lock Active

Settings Able To Be Reset With Lock Active -

Water Hardness
Water Hardness After Mixing Valve
Regeneration Time
Time Of Day

Displays Able To Be Viewed With Lock Active -

Flow Rate Display
Days Since Regeneration Display
Prior Service Volume Used Display
Reserve Capacity Display
Previous Days Water Usage Display

Unlocking Programming -

The only way to deactivate this feature is to push and hold the Program Button for 25 seconds. This procedure will unlock the control and permit all valid program settings to be viewed and reset as needed.

The **UP** and **DOWN Set Buttons** adjust this value.

Exiting This Option Setting Level

Push the Program Button once per display until all have been viewed.

Resetting Permanent Programming Memory -

Push and hold the Program Button for 50 seconds. This procedure will erase this and **all** previous settings and reset them to default values. Control programming will then have to be reset as necessary.